



Human thermal comfort in aircraft cabins

A.M.Abdullah¹, E.E.Khalil², T.M. Abou Deif³, and E.S.Abdelghany⁴

¹Research Assistant, Mechanical Engineering, Faculty of Engineering, Future University, Egypt

²Professor of Mechanical Power Engineering, Faculty of Engineering, Cairo University, Egypt

³Assistant professor of Mechanical Power Engineering, Faculty of Engineering, Cairo University, Egypt

⁴Assistant professor of Aerospace Engineering, Institute of Aviation Engineering and Technology, Egypt

Abstract

Providing thermal comfort and good air quality are important factors to create a healthy and comfortable environment for passengers in airplane. The current ventilation system is the mixed one, 50% of air is fresh air from outside and the other 50% is recirculated air from the cabin. Personalized systems are introduced to improve those two factors. In this research the air distribution system is a combined system between the mixed ventilation system and the gaspers, the effect of the gaspers are investigated on the whole cabin of the economy section of BOEING 777 commercial aircraft. Temperature and velocity distributions are discussed; also PMV and PPD are used to predict the thermal sensation of passengers. It was found that the gaspers increase the air velocity in the cabin, makes the temperature distribution more uniform, and provide thermal comfort for passenger on his demand. The investigation is done by computational fluid dynamics package (ANSYS FLUENT 15.0), FLUENT is the solver, it solves the continuity, momentum, energy, and turbulence model equations. Meshes with sizes between 6,000,000 and 7,000,000 cells are generated in each case. © 2017 ijrei.com. All rights reserved

Keywords: Aircraft cabin, Ventilation system, Thermal comfort, turbulence model

1. Introduction

As we all know at high altitudes the pressure and temperature decrease, airplanes cruise at altitudes ranged from 35,000 to 37,000 ft, the outer environment becomes unsurvivable by humans; For example at 35,000 ft the temperature decreases to -55°C (65°F), the ambient pressure becomes 10.1 KPa (1.5 psi), and water content are dry [1]. Traveling by air is increasing by huge percentage, more than 1 billion passengers annually, 5% of these travels are to the developing world [2,3], in order to protect those passengers from the outer environment and provide them comfort environment an Environmental Control System (ECS) is needed. ECS is an equipment that is responsible for providing the aircraft cabin with suitable and comfort environment by controlling the pressure, temperature, and air quality and setting them to acceptable limits [4]. All modern airplanes air distribution systems consist of 50% filtered recirculated air and 50% outside air, the recirculated air is sterilized by high-efficiency particulate air type filters (HEPA-type) which removes 99.9% of the bacteria and viruses produced by the passengers [5]. Nowadays, all the airlines companies are concerned with achieving the thermal comfort for passengers

as much as they can, many studies were done on different air distribution systems trying to reach the best design that could provide acceptable air quality and comfort environment inside the aircraft cabin.

Chen and Zhang [6] compared between three air distribution systems (mixing, under-floor displacement, and personalized) in a section of a Boeing 767- 300 cabin. For the mixing air distribution, the mixed conditioned air (5 l/s outside air and 5 l/s recirculated air) is supplied from two ceiling inlets with high velocity and extracted through two floor outlets near the side walls at the floor level. The under-floor displacement distribution inlets are along the aisles supplying the same air mixture as in the mixed distribution system, while the outlets were two ceiling outlets. In the personalized air distribution system the inlets were along the aisles and additional inlets were located at the seat-back in front of each passenger, the air is extracted through two ceiling outlets. The results show that the mixing air distribution system had uniform temperature but the highest air velocity and CO₂ concentration; infectious diseases can easily spread from one passenger to the others due to the mixing airflow patterns. In the displacement air distribution system there was a chance

of mixing in the center seating which might be a reason for spreading the infectious diseases. The personalized system showed the lowest CO₂ concentration in the breathing zone as the air is directly supplied to the breathing zone which eliminates the risk of spreading infectious diseases, it also showed low temperature but without a draft risk. The personalized air distribution system created the best cabin environment. Shen et al. [7] studied the impact of gasper airflow on the air quality in the cabin, they measured the distributions of air velocity, air temperature, and gaseous contaminant concentration in an MD-82 commercial aircraft cabin, for 5 rows two-fifth of the gaspers were on next to the aisle. The results were compared to the data obtained from previous study by Sun et al. [8] with all gaspers off, it showed that air velocity was higher when the gaspers were on, also the air temperature was more uniform, but they didn't improve the air quality. This paper is concerned with the study

of the air distribution in aircraft cabin, the air flow patterns inside it, and the effect of gaspers on human thermal comfort, also trying to improve the thermal comfort for the passengers.

2. Model Validation

AIAA defines validation as "The process of determining the degree to which a (CFD) model is an accurate representation of the real world from the perspective of the intended uses of the model" [9].

The chose validation model is an experiment done by Zhang et al. [10] studying different air distributions systems inside the aircraft cabin, the whole experiment was carried out in a double-aisle aircraft cabin mockup which was a prototype of the economy section of a Boeing 767 airplane during cruise.

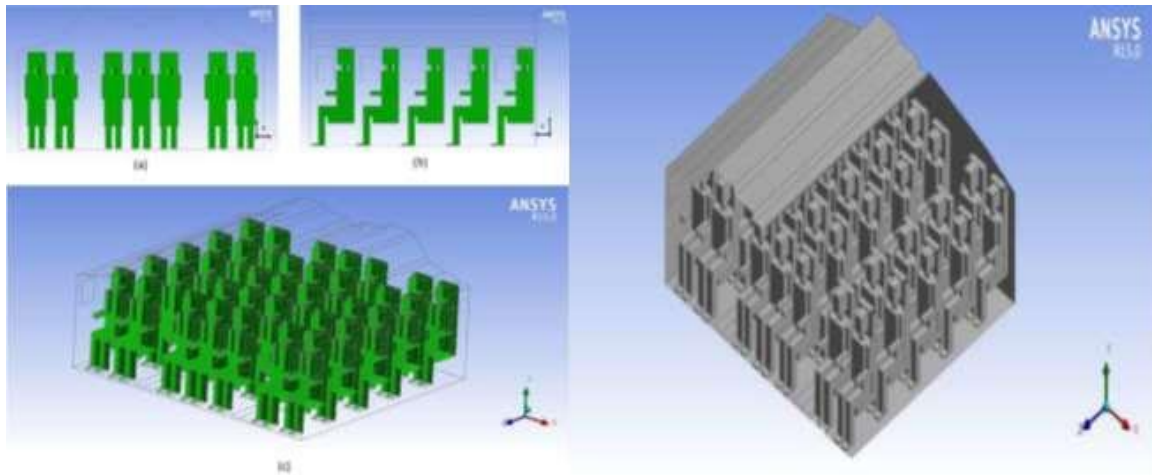

Figure 1: CFD geometry model of full cabin

The same aircraft mockup is reproduced in CFD modeling (Figure 1) with the same boundary conditions (as shown in Table 1), the simulation results will be compared to the

measurements of the first case in Zhang et al. experiment to validate the CFD modeling.

Table 1 Measurement boundary condition in the experimental test [10]

Under-aisle air supply flow rate (m ³ /sec)	0.264
Under-aisle air supply temperature (°C)	22.5
Manikin surface temperature (°C)	31.3
Cabin front section temperature (°C)	25.3
Cabin rear section temperature (°C)	24.9
Ceiling temperature (°C)	27.4
Floor temperature (°C)	24.4
Fluorescent lamp surface temperature (°C)	30
Seat surfaces Adiabatic	Adiabatic

The experimental results were measured at many different locations as shown in Figure 2; Validation is done by

comparing the vertical temperature profile of Pole 3 with the corresponding from CFD modeling.



Figure 2: Plan view of the aircraft cabin and the vertical pole positions [10]

Around 6 million elements (tetrahedral elements) mesh was generated to solve the CFD model, with a minimum element

size of 9.49×10^{-4} m, and maximum element size 0.18980 m, maximum face size 9.49×10^{-2} , and growth rate 1.2.

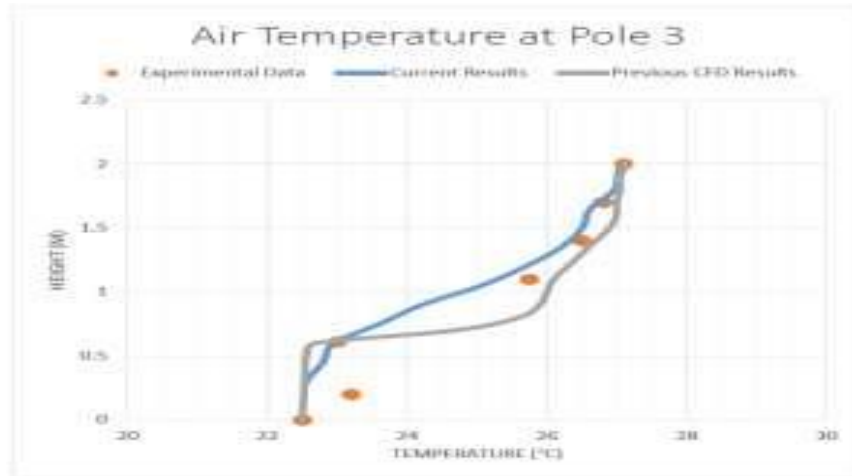

Figure 3: Air temperature vertical profile at pole 3

3. Numerical Model Description

In this research, an economy cabin of BOEING 777 is used, the cabin is double aisled, has 10 seats in each row (3 seats at each side and 4 seats in the middle). The cabin is 6 m wide

and the maximum height is 2.4 m, 4 rows are modeled (longitudinal length is 3.5 m), 40 seats are occupied by passengers, lighting was modeled by two fluorescent lamps at the ceiling.

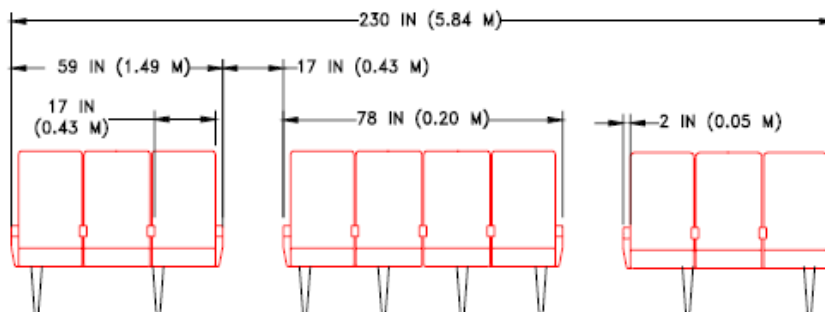

Figure 4: Economy Class seating (Ten-Abreast)

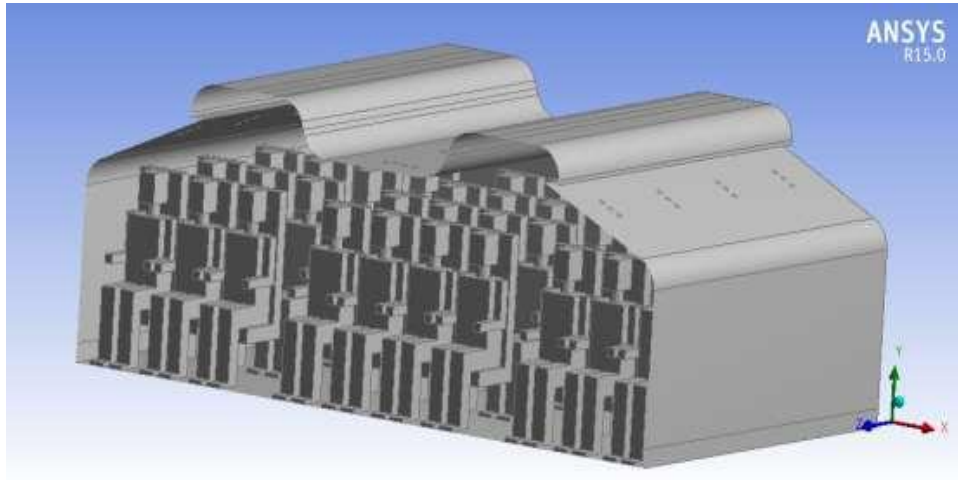

Figure 5 Cabin Geometry with passengers

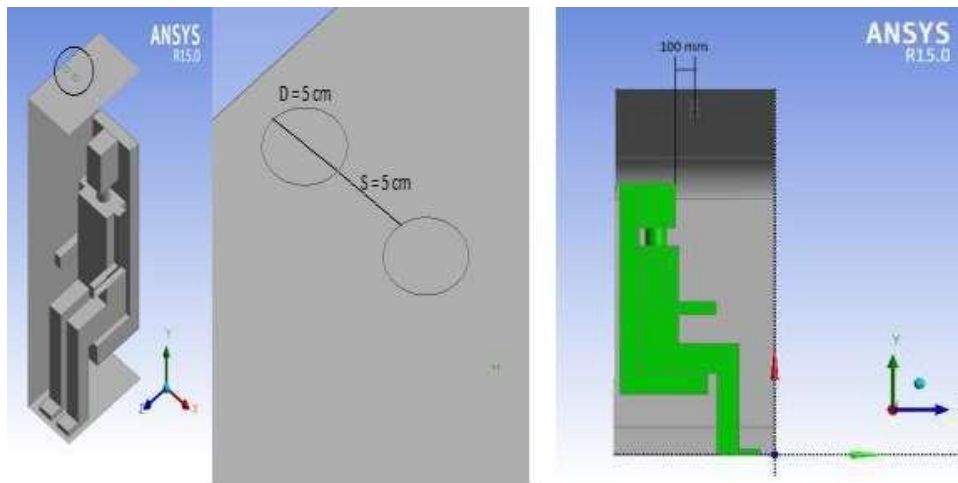

Figure 6: Dimensions and location of gaspers

4. Case Studies

Case 1: The Ventilation system is combined between the mixed ventilation system and the personalized ventilation system represented as "gaspers". The gaspers are round jets with 5 cm diameter installed above the passengers' heads, the distance between the gaspers and the passengers equals 100

mm in the longitudinal direction, and the space between each two gaspers is 5 cm as shown in figure 6. Air enters the cabin from two longitudinal inlets at the ceiling with angle equal 80° and gaspers above each seat and exits from two outlets at the side walls.

Case 2: Same as case 1 except for the spacing between gaspers, 30 cm instead of 5 cm with a lower temperature.

Case 3: Same as case 1 and 2 but without gaspers

Table 2 Boundary conditions for cases 1, 2, and 3

Turbulence model	RNG k-ε	RNG k-ε	RNG k-ε
Ceiling temperature (°C)	24	24	24
Floor temperature (°C)	26	26	26
Fluorescent lamps temperature (°C)	27	27	27
Passengers' temperature (°C)	30	30	30
Ceiling inlets air supply flow rate (l/s per passenger)	8/80 ⁰	8/80 ⁰	10/80 ⁰
Ceiling inlets air supply temperature (°C)	15	18	15

5. Results and Discussions

For the four rows, temperature contours, velocity contours,

PMV, and PPD will be presented and discussed in each case. The planes' locations at which the measurements were taken for the four rows are as shown in the following figures.

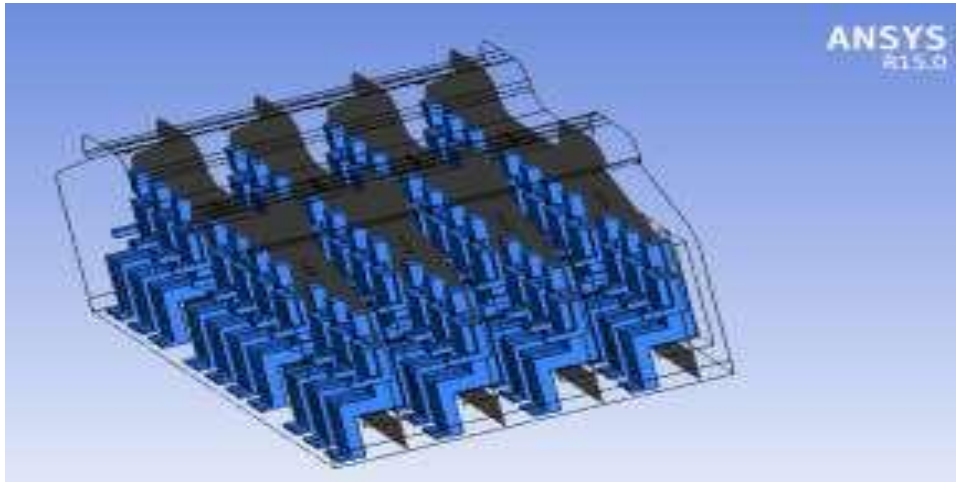
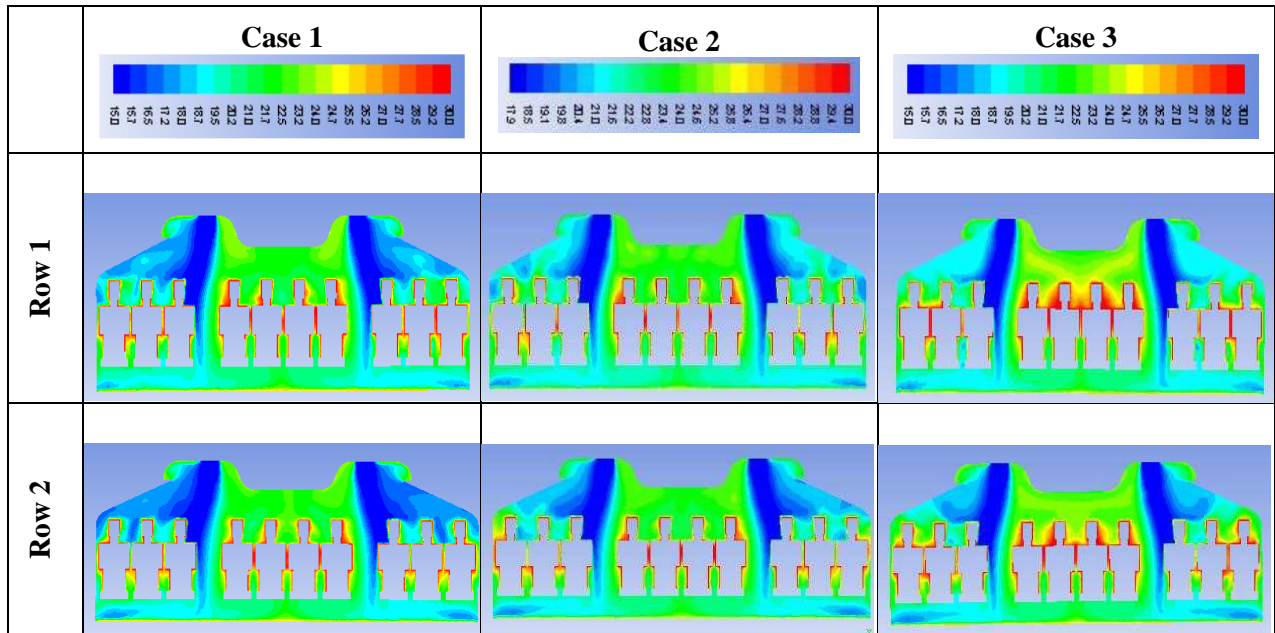

Figure 7: Planes locations

5.1 Temperature Contour

For cases 1 and 3, as shown in Figure 8, the temperature distribution is much better when gaspers are on. The gaspers decreased the high temperature regions and make the temperature distribution more uniform and with acceptable

values for the middle section the (21.5⁰C) and the sides of the cabin (18.5⁰C).For case 2, the temperature is 23⁰C in the middle section and 20.5⁰C at the sides, the maximum vertical difference is 2⁰C and the maximum horizontal difference is 5⁰C which are acceptable by ASHRAE [11].



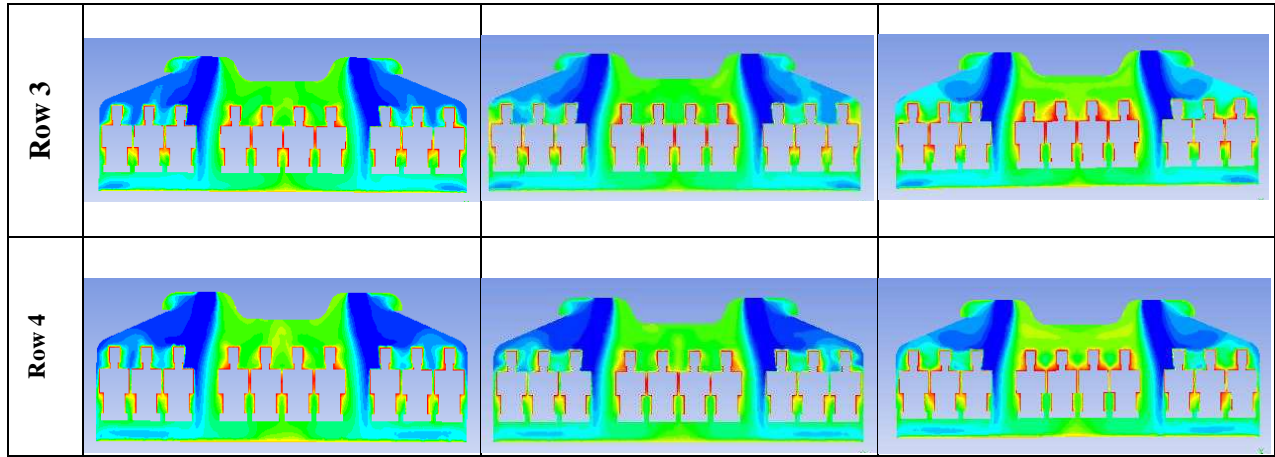

Figure 8: Predicted Temperature contours at various rows

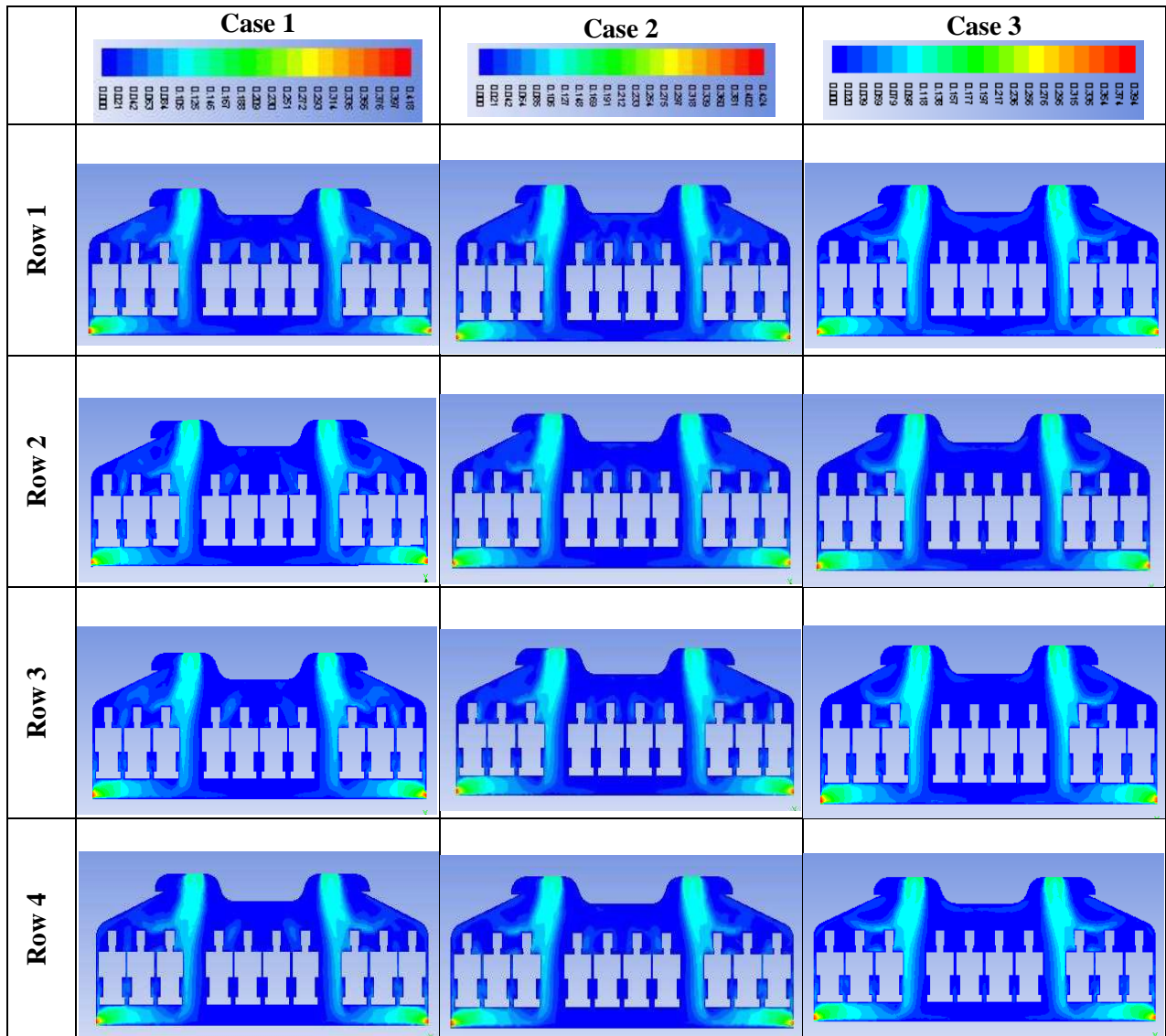

Figure 9: Predicted Velocity contours at various rows

5.2 Velocity contour

For cases 1 and 3, the ventilation is good at the sides of the cabin but for the middle section passengers, they will depend on the gaspers for better ventilation as indicated in Figure 9. For case 2, air velocity around passengers is 0.1 m/s, with the aid of gaspers for additional ventilation the ventilation of the whole cabin will be sufficient and comfortable for passengers. The predicted contours of PMV are shown in Figure 10 for

cases 1 and 3, PMV is much better when gaspers are on, also it is improved for the middle section and becomes 0.3 when gaspers are on which means that the four passengers in the middle are thermally comforted. At the sides PMV becomes -0.6 and reaches -0.9 at some regions as the temperature of the air is decreased. For case 2 that is also shown in Figure 10, the value of local PMV is improved for the whole cabin, for 85% PMV values range from 0 to 0.3 and for the rest 15% it ranges from 0.3 to 0.7 overall it is acceptable and comfortable.

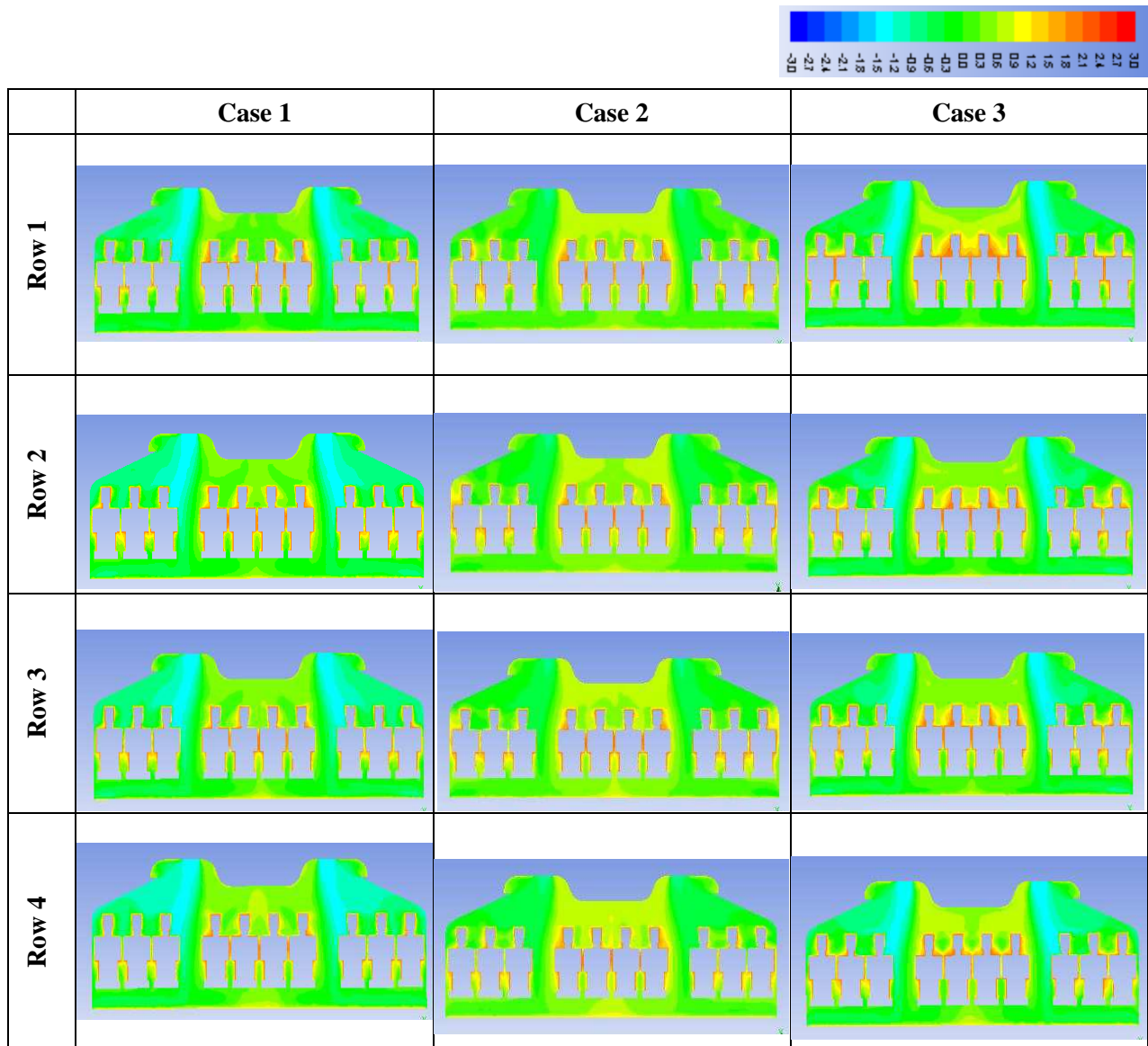

Figure 10: Comparison between PMV values for the three cases

5.3 PMV contour

For cases 1 and 3, shown in Figure 11, the values of the PPD are around 10% for the whole cabin when gaspers are on except for the passengers at the side at the aisles, as the air is closer to him at lower temperature,

consequently the passenger will feel a little cold. For case 2, PPD is improved and ranges from 0 to 10% for 85% of the cabin, and from 10 to 25 for 15%.

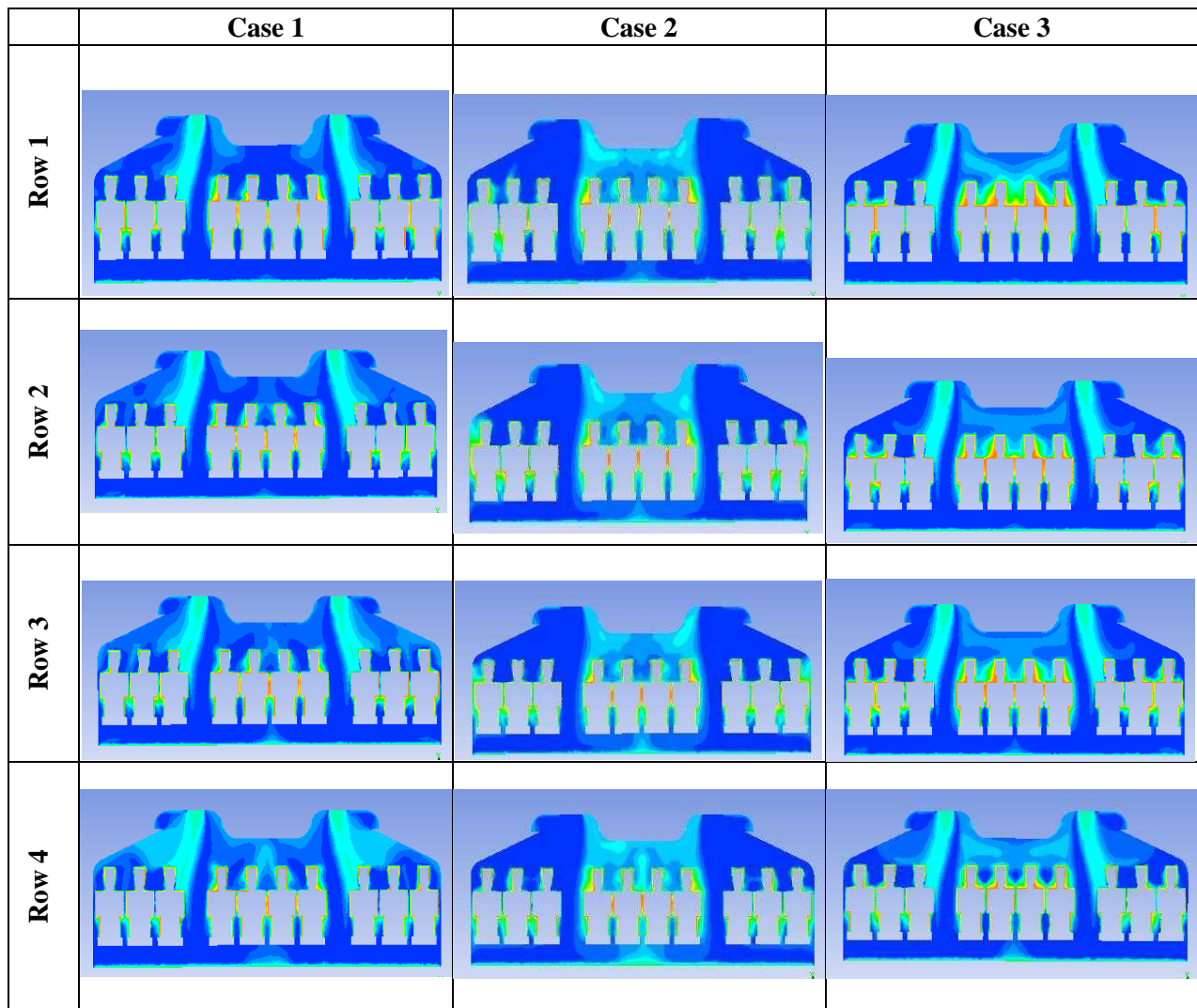

Figure 11: Comparison between PPD values for the four cases

6. Conclusions

- Combining the mixed air and personalized ventilation system provides better ventilation.
- Gasps increase the velocity of air in cabin and make the temperature more uniform.
- The locations of gasps affect the thermal comfort, as it gets nearer to the passenger the thermal comfort feelings improves.

References

- [1] National Academy of Sciences, "Environment and the Health of Passengers and Crew." 2002.
- [2] Ryan,E.T., Wilson,M.E., and Kain,K.C., "Illness After International Travel," English J., vol. 347, no. 7, 2011.
- [3] Mangili, A. and Gendreau, M. , "Transmission of infectious diseases during commercial air travel," Lancet, vol. 365, no. 9463, 2005.
- [4] Martinez, I., "Environmental control system in aircraft," 2014.
- [5] Hunt, E. H., Reid, D. H., Space, D. R., and Tilton, F. E., "Commercial airliner environmental control system," Proc. Aerosp. Med. Assoc. Annu. Meet. Anaheim USA, 1995.
- [6] Zhang, T. and Chen, Q. (Yan), "Novel air distribution systems for commercial aircraft cabins," Building and Environment, vol. 42, no. 4, 2007.
- [7] Li, B. , "Experimental studies of thermal environment and contaminant transport in a commercial aircraft cabin with gaspers on," Indoor Air, 2015.
- [8] Liu, W. , "Accurate and high-resolution boundary conditions and flow fields in the first-class cabin of an MD-82 commercial airliner," Atmos. Environ., vol. 56, 2012.
- [9] AIAA, "Guide for the Verification and Validation of Computational Fluid Dynamics Simulations," AIAA, vol. 1998, 1998.
- [10] Zhang, T. T., Li, P., and Wang, S., "A personal air distribution system with air terminals embedded in chair armrests on commercial airplanes," Building and Environment, vol. 47, no. 1, 2012.
- [11] ASHRAE Standard 55-2013, "Thermal environmental conditions for human occupancy," 2013.